

Futaba Rate Gyro for RC Drift Cars
GYD450
 Only for Futaba digital servo
 For RC models
INSTRUCTION MANUAL

Before using your new gyro, please read this manual thoroughly and use the gyro properly and safely. After reading this manual, store it in a safe place.

- No part of this manual may be reproduced in any form without prior permission.
- The contents of this manual are subject to change without prior notice.
- Futaba is not liable for any potential damage (accidental or otherwise) that may occur after installation.

Features of GYD450

- Dedicated RC Drift car setting**
 Vehicle straight-line and cornering performance can be increased without taking into account the effect of the road surface, etc.
- Remote gain function and mode switching function**
 You can adjust gain from the transmitter (3 or more CH) by using the remote gain function. Gain can also be adjusted with the trimmer on the GYD450. The mode switching function allows AVCS/NORMAL gyro mode switching.
- Integrated, compact, and light weight**
 Compact size (20.5x20.5x11mm) and light weight (3.7g) realized by high density mounting technology.
- Easy setup**
 The GYD450 can be used immediately with minimum setup.
- Supporting the S.BUS/S.BUS2 connection**
 Only one wire connection to the receiver can operate the GYD450.
- Only for Futaba digital servo**

Functions

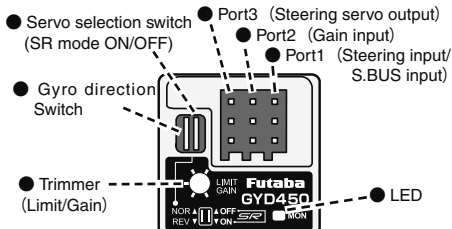

Monitor LED display

State	Color	Move	Reference
1. No servo pulse / sensor error	Red	2 flash	
2. Warm-up	Green	Fast blink	
3. Sensor initialization	Red/Green	ON	AVCS (Red) NORMAL (Green)
4. Turn	Red/Green	Fast blink	Right (Green) Left (Red)
5. Neutral offset	Orange	Slow blink	Stick operation
6. Gain OFF	-	OFF	
7. Switch operation	Green	One blink	Each time of switch operation
8. Low battery	Red	One flash	Less than 4.0V

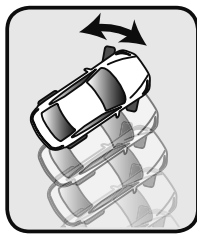

Thank you for purchasing the GYD450 RC cars gyro. Compact and lightweight, the GYD450 is designed to control steering for RC Drift cars. If the transmitter has 3 or more channels (capable of 3CH adjustment) the gyro sensitivity can be adjusted from the transmitter. Features include simple set-up and S.BUS/S.BUS2 connectivity.

GYD450 Ratings:
 (Integrated sensor type rate gyro)

- Gyro sensor: MEMS vibrating structure gyro
- Operating voltage: DC4.2V to 8.4V
- Current drain: 30mA (excluding a servo)
- Operating temperature range: -10°C to +45°C
- Dimensions: 20.5 x 20.5 x 11.0mm (0.8 x 0.8 x 0.43in) (except protrusion)
- Weight: 3.7g (0.13oz)
- Functions: Sensitivity trimmer. LED monitor. Servo selection (SR mode ON/OFF). S.BUS/S.BUS2 connection.

Set Contents

The following items are supplied with the GYD450:

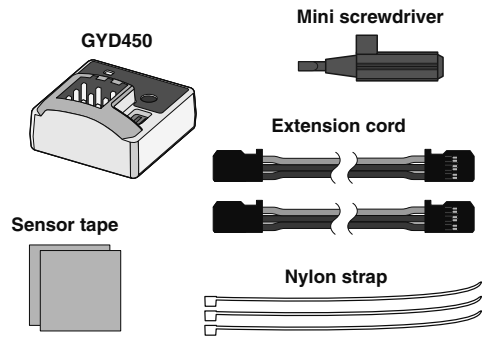

WARNING

- Failure to follow these safety precautions may result in severe injury to yourself and others.
- Check that there is sufficient battery capacity.
 - Do not operate the model and transmitter steering wheel for about 3-5 seconds after turning on the GYD450 (When shared with the receiver).
 - GYD450 initialization and neutral position reading. The GYD450 is initialized when the power is turned on. The neutral position is also read at the same time. If initialization ends normally, the operator is informed by two repetitive movements of the servo to the left and right (a little).
 - Always check the direction of operation of the gyro.
 - Do not strike the gyro with a hard object. Do not drop it onto a concrete surface or other hard floor.
 - The sensor may become damaged during strong impacts.
 - Do not use trims or mixing.
 - All corrections are made by the gyro. Therefore, if trimming and mixing, are turned on, operation will be the same as deviating from the neutral position.
 - Do not use the GYD450 for applications other than RC cars.
 - This gyro is designed for RC cars only. Do not use it for other applications.
 - Analog servos cannot be used.
 - The use of analog servos may cause servo trouble.
 - Do not place gyro near heating equipment (engine, motor, ESC, battery, servo, etc.).
 - Always allow the gyro to adjust to the surrounding environmental temperature before flight. A large temperature change during use will cause drift and other operational issues.

Connecting the GYD450 **S.BUS Connecting the GYD450**

- Gyro gain CH(Receiver)←connect→Port2(GYD450)
 Remote gain effective. Trimmer(GYD450) becomes LIMIT.
- Gyro gain CH(Receiver)←It does not connect→Port2(GYD450)
 Remote gain is invalid. Trimmer(GYD450) becomes GAIN.

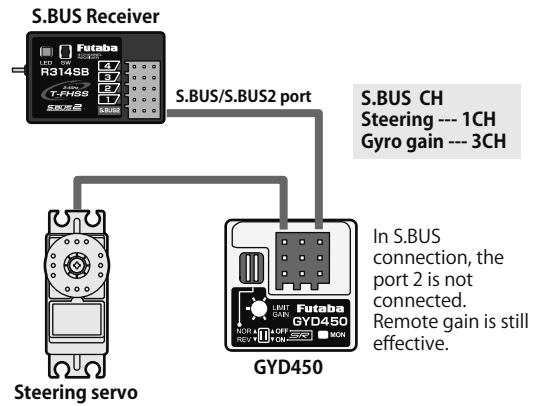
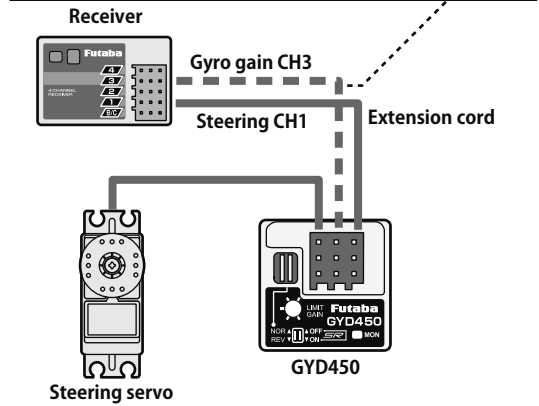

Mounting to Chassis

Use the included double-sided sponge tape to firmly attach the gyro perpendicular to the control axis, at a position where there is as little vibration as possible. Make the

wiring loose and bundle it with the included nylon strap so that it will not interfere with the rod.

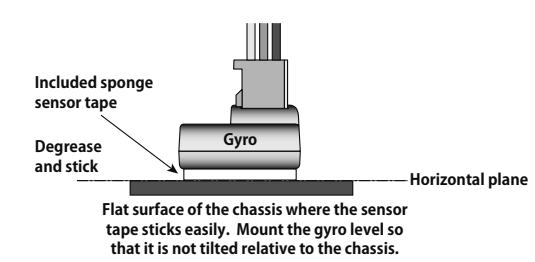
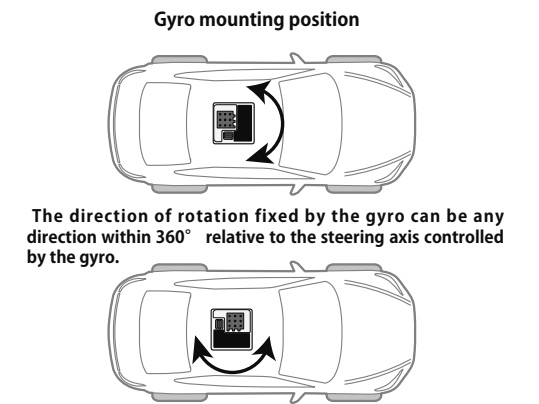

Steering servo

Link the servo in accordance with the kit instruction manual. Adjust the linkage rod so that the trim amount is as small as possible.
 When using S.BUS servo, initialize a parameter.
 Make the servo operating range as wide as possible.
 Make the numerical value of EPA (ATV) equally in left and right.

SR mode

It is possible when using the T7PX to change the servo to "SR Mode" and improve the servo response. If the servo can't be changed to SR mode, do not set the TX to SR mode.

Adjustments

Setup before a run [Remote gain use]

Gain adjustments are carried out with a transmitter.

Follow this procedure when the port 2 of gyro and gain CH of the receiver are connected. (or with S.BUS connection)

- 1 Run the car in the gyro off (**gyro gain 0%**) and adjust the **steering trim** (sub trim).
- 2 Select the appropriate setting for the steering servo that you are using. Servo selection switch of GYD450 should be moved to **SR mode ON** or **OFF**.

*Do not use a normal digital servo in the SR servo mode (ON). The servo may be damaged. Use a normal digital servo in the SR servo mode (OFF).

- 3 Turn on your transmitter's power. Set the gyro sensitivity to about 70% at the NORMAL or AVCS side in accordance with the transmitter instruction manual. The <GAIN CH><AVCS / NORMAL Modes> graph of the next page is referred to.

Gyro sensitivity zero --- LED OFF
AVCS side --- LED red
NORMAL side --- LED green

*Make the gain tuning adjustment after running the car and noting the behavior.

- 4 Receiver ON → The GYD450 requires 3-5 seconds to initialize when the power is turned on. Do not move the car and do not move the steering wheel during this initialization or the gyro may not initialize properly. Once the initialization process has been completed the steering servo will move (a little) several times indicating that the GYD450 is now ready for use. If the neutral has shifted, LED will blink orange. In that case, it reboots.

- 5 Move the steering wheel to the left and right and perform adjustment at the limit trimmer so that the servo operation is maximum without any bind of the control linkage or mechanical limits.

<Limit Trimmer Adjustments>

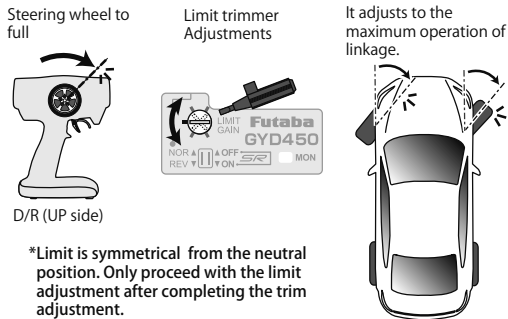

● Trimmer operation

*Since this gyro is also very small, the adjustment trimmer is also a small part. Always operate the trimmer with the accessory mini screwdriver and without applying unreasonable force.

- 6 Using the gyro direction switch, adjust the gyro operating direction so that steering moves all the way to the right when the car is turned to the left. Be sure to set gyro operating direction correctly or the car will not run.

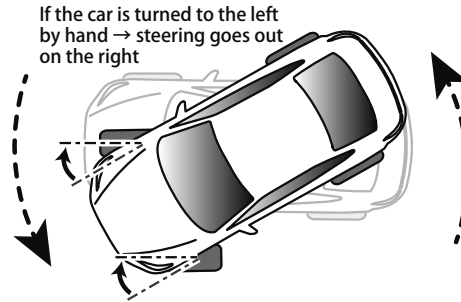

[When remote gain function is off]

Adjust the gyro sensitivity with the GYD450 trimmer.

If the port 2 of gyro is not connected, remote gain is automatically set to being inhibited. (S.BUS connection is excluded)

In this case, the limit trimmer is automatically changed to gyro sensitivity setting trimmer.

(Limit adjustment cannot be performed. A limit is fixed to 50 right and left.)

- 1 Select the appropriate setting for the steering servo that you are using. Servo selection switch of GYD450 should be moved to **SR mode ON** or **OFF**.

*Do not use a normal digital servo in the SR servo mode (ON). The servo may be damaged. Use a normal digital servo in the SR servo mode (OFF).

- 2 Gain trimmer halfway to the left : NOMAL(green) or right : AVCS (red) from the 70% point.

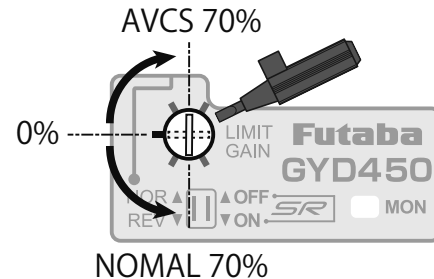

- 3 Receiver ON → The GYD450 requires 3-5 seconds to initialize when the power is turned on. Do not move the car and do not move the steering wheel during this initialization or the gyro may not initialize properly. Once the initialization process has been completed the steering servo will move (a little) several times indicating that the GYD450 is now ready for use. If the neutral has shifted, LED will blink orange. In that case, it reboots.

- 4 Using the gyro direction switch, adjust the gyro's operating direction so that steering moves all the way to the right when the car is turned to the left. Be sure to set the operating direction correctly or the car will not run.

Gyro Sensitivity and mode Switching

When the remote gain function is used, **NORMAL** and **AVCS** mode switching is performed in accordance with the direction of operation of the transmitter's remote gain channel. At the + rate side, the **AVCS** mode is selected and at the - rate side, the **NORMAL** mode is selected. The sensitivity is changed by adjusting the end point rate.

When the remote gain function is not used, the clockwise direction from the center of the sensitivity setting trimmer is the **AVCS** mode and the counterclockwise direction is the **NORMAL** mode. At the center position the sensitivity becomes zero and when the trimmer is turned fully to the left or right, the sensitivity becomes 100%.

The sensitivity setting criteria by end point is shown in the figure below.

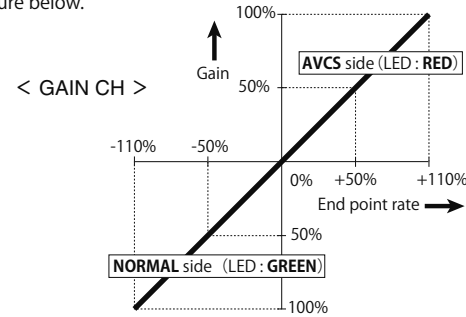

3CH (GAIN CH) is set up with reference to the manual of a transmitter. Neutral position becomes GAIN 0%. It is divided into AVCS side and NORMAL side. Check using the GYD450's LED.

Gyro sensitivity zero --- LED OFF
AVCS side --- LED red
NORMAL side --- LED green

When Port 2 is not used for gain, and SBUS/SBUS2 is not used, the trimmer works as the gain adjustment shown below.

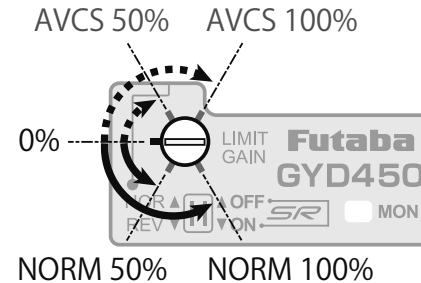

Tuning Adjustment

Actually drive the vehicle and adjust the gyro sensitivity.

- 1 Always re-trim with the **gyro gain at 0**.
- 2 In this state turn the **receiver power OFF → ON**. The neutral position is memorized. Steering trim must not be performed while the car is running.

AVCS / NORMAL Modes

The gyro has 2 operating modes: **NORMAL** mode and **AVCS** mode. In the **AVCS** mode, **gyro control is firmer**. The car will hold heading via the drivers commands.

In **NORMAL** mode the gyro will try to counter steer, but still allow the car to drift regardless of previous heading.

Because the feel of operation is different, choose your favorite mode.

AVCS

In case of the right slide → Right steering control
The gyro will try to get the car to grip in the drivers steering direction.

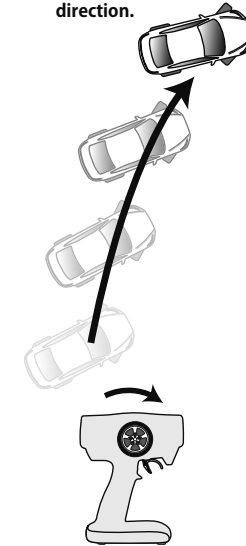

NORMAL

In case of the right slide → Left steering control
The gyro will try to counter steer regardless of the angle of the car.

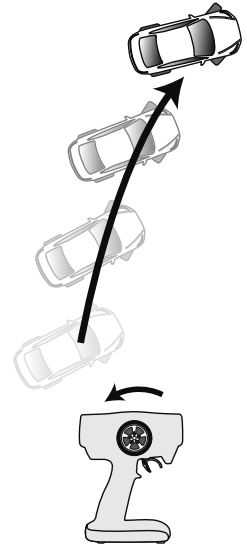

S.BUS System

Unlike conventional radio control systems, the S.BUS system sends operating signals from the receiver to a gyro or other S.BUS compatible device by data communication. The S.BUS compatible device executes only those parts of this data for the channels set by itself. For this reason multiple servos can be connected to the same signal line.

The S.BUS system requires a dedicated S.BUS receiver and S.BUS servo (gyro, etc.).