

2HR

Frequency Hopping Spread Spectrum

2.4GHz
FHSS
2.4GHz System
SPREAD SPECTRUM



INSTRUCTION MANUAL

*2 Channel-FHSS-2.4GHz
Radio control system
for Car R/C System*

1M23N30402

Futaba[®]

Digital Proportional R/C System

2HR

Frequency Hopping Spread Spectrum

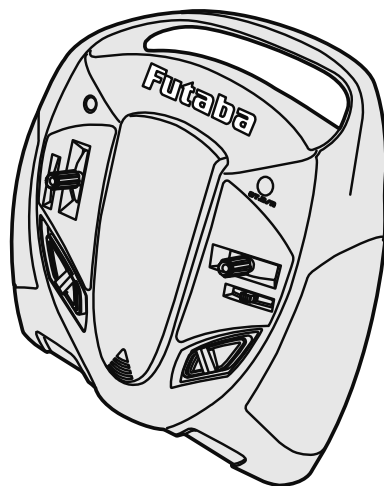

Instruction manual

Thank you for purchasing a Futaba FHSS 2HR 2.4GHz system.

This system is based on the combination of the newly developed 2.4GHz transmitter and its corresponding receiver. Before using your 2HR 2.4GHz system, read this manual carefully and use your R/C set safely.

After reading this manual, store it in a safe place.

FHSS 2HR 2.4GHz system

- Frequency channel setting unnecessary: Shifting the channels within the 2.4GHz band automatically, this system minimizes the interference from other 2.4GHz systems.
- FHSS (Frequency Hopping Spread Spectrum) minimizes interference from other 2.4GHz systems. This system is not compatible with FASST.

Application, Export, and Modification

1. This product may be used for models only. It is not intended for use in any application other than the control of models for hobby and recreational purposes.
2. Exportation precautions:
 - (a) When this product is exported from the country of manufacture, its use is to be approved by the laws governing the country of destination which govern devices that emit radio frequencies. If this product is then re-exported to other countries, it may be subject to restrictions on such export. Prior approval of the appropriate government authorities may be required. If you have purchased this product from an exporter outside your country, and not the authorized Futaba distributor in your country, please contact the seller immediately to determine if such export regulations have been met.
 - (b) Use of this product with other than models may be restricted by Export and Trade Control Regulations, and an application for export approval must be submitted.
3. Modification, adjustment, and replacement of parts: Futaba is not responsible for unauthorized modification, adjustment, and replacement of parts on T2HR. Any such changes may void the warranty.
4. Changes or modifications not expressly approved by the party responsible for compliance could void the user's authority to operate the equipment.

Compliance Information Statement (for U.S.A.)

This device, trade name Futaba Corporation, model number T2HR-2.4G, complies with part 15 of the FCC Rules. Operation is subject to the following two conditions:

- (1) This device may not cause harmful interference, and
- (2) This device must accept any interference received, including interference that may cause undesired operation.
- (3) This device complies with FCC radiation exposure limits set forth for an uncontrolled environment. This equipment should be installed and operated with minimum distance 20 cm between the radiator and your body.

The responsible party of this device compliance is:

Futaba Service Center

3002 N Apollo Drive Suite 1, Champaign, IL 61822 U.S.A.

TEL (217)398-8970 or E-mail: support@hobbico.com (Support)

TEL (217)398-0007 or E-mail: futabaservice@hobbico.com (Service)

Battery Recycling (for U.S.A.)



The RBRC™ SEAL on the (easily removable) nickel-cadmium battery contained in Futaba products indicates that Futaba Corporation of America is voluntarily participating in an industry program to collect and recycle these batteries at the end of their useful lives, when taken out of service within the United States. The RBRC™ program provides a convenient alternative to placing used nickel-cadmium batteries into the trash or municipal waste system, which is illegal in some areas.

You may contact your local recycling center for information on where to return the spent battery. Please call 1-800-8-BATTERY for information on Ni-Cd/Ni-MH battery recycling in your area. Futaba Corporation of America's involvement in this program is part of its commitment to protecting our environment and conserving natural resources.

RBRC™ is a trademark of the Rechargeable Battery Recycling Corporation.

Safety Precautions	6
Definition of Symbols	6
2.4GHz System Precautions	6
Operation Precautions	7
Storage and Disposal Safety Precautions	8
Other Safety Precautions	9
Before Operation	10
System Contents	10
Nomenclature / Handling	11
Battery Replacement Method	14
Assembly / Adjustment	18
Receiver and Servo Connection	18
Receiver Antenna Installation	18
Assembly Precautions	19
How to Link Transmitter and Receiver	20
Fail Safe Function (F/S)	21
Transmitter Set-Up Procedures	22
2HR-2.4G Functions	23
Steering Trim	23
Throttle Trim	23
Steering Dual Rates (D/R)	24
Servo Reversing	24
MC231CR/MC331CR	25
Changing the Neutral Position	27
Modifying the Throttle Stick to a Ratchet Type	28
Reference	29
Ratings	29
Troubleshooting	30
Error Displays	31
When Requesting Repair	31

Safety Precautions

Before Operation

Assembly / Adjustment

2HR-2.4G Functions

Reference

Warning: This product contains a chemical known to cause cancer and birth defects (or other reproductive harm).



- No part of this manual may be reproduced in any form without prior permission.
- The contents of this manual are subject to change without prior notice.
- This manual has been carefully written. Please write to Futaba if you feel that any corrections or clarifications should be made.
- Futaba is not responsible for the use of this product.

For your safety as well as that of others, please read this manual thoroughly prior to installation and operation of your digital proportional R/C system.

Definition of Symbols

The following defines the symbols used in this manual.

Explanation of Symbols

 DANGER	Procedures which may lead to a dangerous condition and cause death or serious injury to the user if not carried out properly.
 WARNING	Procedures which may lead to a dangerous condition or cause death or serious injury to the user if not carried out properly, or procedures where the probability of superficial injury or physical damage is high.
 CAUTION	Procedures where the possibility of serious injury to the user is small, but there is a danger of injury, or physical damage, if not carried out properly.

Explanation of Graphic Symbols

 Indicates an operation that prompts a warning (including Caution).

 Indicates an operation that must not be performed.

 Indicates an operation that always must be performed.

2.4GHz System Precautions

WARNING

 Do not cover/hold the built-in antenna part of T2HR-2.4G transmitter by your hand during running. Do not put any conductive plate/sticker on the antenna part. Otherwise, the operating range may become shorter.

 Do not perform the linking procedure while motor's main wire is connected or the engine is operating as it may result in serious injury.

 While the linking is done, please cycle receiver power and check if the receiver to be linked is really under the control by the transmitter to be linked.

 Always use R202GF 4.8V~7.4V rechargeable battery or regulated output from ESC. Using dry cell batteries may cause the system to malfunction. When using an ESC, be sure that the regulated output capacity meets your usage condition.

 In order to maintain complete control of your car/boat it is important that it remains visible at all times. Running behind large objects is not suggested. Doing so may result in the reduction of the quality of the radio frequency link to the model.

Operation Precautions

WARNING

 When using a Ni-Cd/Ni-MH battery to power your system, always charge and check the battery voltage prior to operation. Should the battery discharge below the minimum voltage level, control will be lost.

 Prior to operation always perform a range test. Even one abnormality in the R/C system may cause loss of control.

[Range Test Procedure]

Have a friend hold the model, or place on a stand where the Sticks or prop can not come in contact with any object. Operate from a distance of about 100 feet. Be sure to check the movement of each servo to make sure it follows the movement of the steering Stick and throttle Stick. If the servos do not follow the commands from the transmitter or any type of interference is detected, Do Not operate the model.

 Never operate in the rain or run through puddles. The transmitter, receiver, batteries and most servos, and speed controls are not waterproof. Contact with any type of moisture or immersion in water or snow will cause damage along with possible loss of control. Should any type of moisture enter any component of the system, immediately stop using the R/C system and return it to our service center for inspection.

 Do not operate when visibility is limited. Should you lose sight of the model, a collision or other dangerous situation may occur.

 Do not operate near people or roads. Do not operate on any pond when boats are present. Do not operate near high tension power lines or communication broadcasting antennas. Prior to the operation of any model be sure the area you plan to use is safe. Be aware of all objects that may be in the path of your model. Do not operate the model where people or any type of moveable object could stray in the path of your model. Control loss due to interference, component failure, loss of sight or low battery voltage could result in serious injury to yourself and others as well as damage to your model.

 Do not operate when you are tired, not feeling well or under the influence of alcohol or drugs. Your judgment is impaired and could result in a dangerous situation that may cause serious injury to yourself and others.

 **(Turning on the power switches)** Always check the throttle Stick on the transmitter to be sure it is at the neutral position.

1. Turn on the transmitter power switch.
2. Turn on the receiver or speed control power switch.

(Turning off the power switches)

Always be sure the engine is not running or the motor is stopped.

1. Turn off the receiver or speed control power switch.
2. Then turn off the transmitter power switch.

If the power switches are turned off in the opposite order the model may unexpectedly run out of control and cause a very dangerous situation.

 Make all adjustments to the radio control system with engine not running, or the electric motor disconnected.
If the engine is running or the motor is connected while adjustments are made, the model may run out of control.

 Remove the main battery source from electric powered models when they are not being used. Should you accidentally leave the receiver switch on, the model could run out of control.

 **(Fail safe function)**
Before running (cruising), check the fail safe function.

Check Method:

Before starting the engine, check the fail safe function as follows:

1. Turn on the transmitter and receiver power switches.
2. Turn off the transmitter power switch.
3. Check if the fail safe function moves the servos to the preset position when reception fails.

The fail safe function is a safety feature that minimizes set damage by moving the servos to a preset position when reception fails. However, if set to a dangerous position, it has the opposite effect.

Setting example: Throttle idle or brake position

 **CAUTION**

 Do not touch the engine, motor, speed control or any part of the model that will generate heat while running.
Touching hot parts will result in serious burns.

 When the charger is not in use, disconnect it from the outlet. This will prevent accidents, overheating and short circuits.

Storage and Disposal Safety Precautions

 **WARNING**

 At the end of a day's operation, store the system with Ni-Cd/Ni-MH battery discharged. Be sure to recharge the system before it is used again.
You should fully discharge your system's batteries periodically to prevent a condition called "memory". For example, if you only make two runs in a day or you regularly use a small amount of battery's capacity, the memory effect can reduce the actual capacity even if the battery is charged for the recommended amount of time.

 Do not throw a Ni-Cd/Ni-MH battery into a fire. Do not disassemble or attempt to repair a Ni-Cd/Ni-MH battery pack.
Overheating, damage and acid leakage may lead to burns, loss of eye sight as well as numerous other types of injuries. The electrolyte in Ni-Cd/Ni-MH batteries is a strong alkali. Should you get even the smallest amount of the electrolyte in your eyes, Do Not rub. Wash immediately with water, and seek medical attention at once. The electrolyte can cause blindness. If electrolyte comes in contact with your skin or clothes, wash with water immediately.

 Do not leave the radio system or models within the reach of small children. A small child may accidentally operate the system. This could cause a dangerous situation and injuries. Ni-Cd/Ni-MH batteries can be very dangerous when mishandled and cause chemical damage.

CAUTION

 Do not store your R/C system where it will be exposed to the following conditions.

- Extreme heat or coldness
- Exposed to direct sunlight
- Where humidity is high
- Where vibration is prevalent
- Where dust is prevalent
- Where there is steam and condensation

Storing your R/C system under adverse conditions could cause deformation and numerous other problems with operation.

 If the system will not be used for a long period of time, remove the batteries from the model and store in a cool, dry place.

If the batteries are left in the model, electrolyte may leak and damage the model.

<Ni-Cd/Ni-MH Battery Recycling>

A used Ni-Cd/Ni-MH battery is valuable resource. Insulate the battery terminals and dispose of the battery by taking it to a battery recycling center.

Other Safety Precautions

CAUTION

 When operating two or more models at the same time, have a third person act as a spotter. They will be in charge of safety and you should follow their instructions.

 Beginners should receive instructions regarding safety and operation from an experienced modeler.

 Always use only genuine Futaba transmitter, receivers, servos, and electronic speed controls, along with other optional parts and components.

Futaba will not be held responsible for damages caused by other than genuine Futaba parts and components. Use only genuine Futaba parts and components listed in the instruction manual and catalog.

 Do not short circuit the Ni-Cd/Ni-MH battery terminals.
Short circuiting the terminals will lead to sparks and overheating and could cause a fire and burns as well.

 Do not expose plastic parts to fuel, motor spray, waste oil or exhaust.
The fuel, motor spray, waste oil and exhaust will penetrate and damage the plastic.

<Ni-Cd/Ni-MH Battery Electrolyte>

The electrolyte in Ni-Cd/Ni-MH batteries is a strong alkali. Should you get even the smallest amount of the electrolyte in your eyes, DO NOT RUB. Wash immediately with water and seek medical attention at once. The electrolyte can cause blindness. If electrolyte comes in contact with your skin or clothes, wash with water immediately.

System Contents

After opening the container, check the contents for the following items. The contents will vary with the system purchased.

2HR-2.4GHz System Contents				
Transmitter	T2HR-2.4G (x1)			
Receiver	R202GF (x1)			
Servo	----	S3003 (x2)	S3003 (x1)	S3003 (x1)
E.S.C.	----	----	MC231CR (x1)	MC331CR (x1)
Switch	SSW-GS (x1)		----	----
Miscellaneous	Mini Screwdriver *Servo mounting hardware and servo horns (only w/servo set)			

NOTE: Futaba FHSS system, T2HR-2.4G transmitter and R202GF receiver, does not work with current Futaba FASST/FASSTest/T-FHSS systems. Please use T2HR-2.4G and R202GF in pairs. Futaba FASST/FASSTest/T-FHSS system and FHSS system are not compatible each other.

Receiver R202GF

LED Link Switch

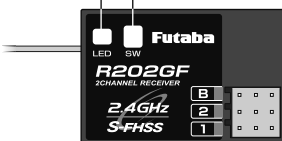

Connectors

- "B": Power connector
- "2" : Throttle Servo (CH2)
- "1" : Steering Servo (CH1)

Servo S3003

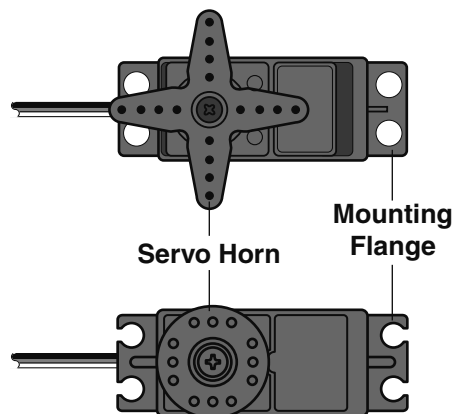

Nomenclature / Handling

Transmitter T2HR-2.4G

⚠ WARNING



As with all radio frequency transmissions, the strongest area of signal transmission is from the sides of the antenna(built-in). As such, the antenna(arrow direction) should not be pointed directly at the model.

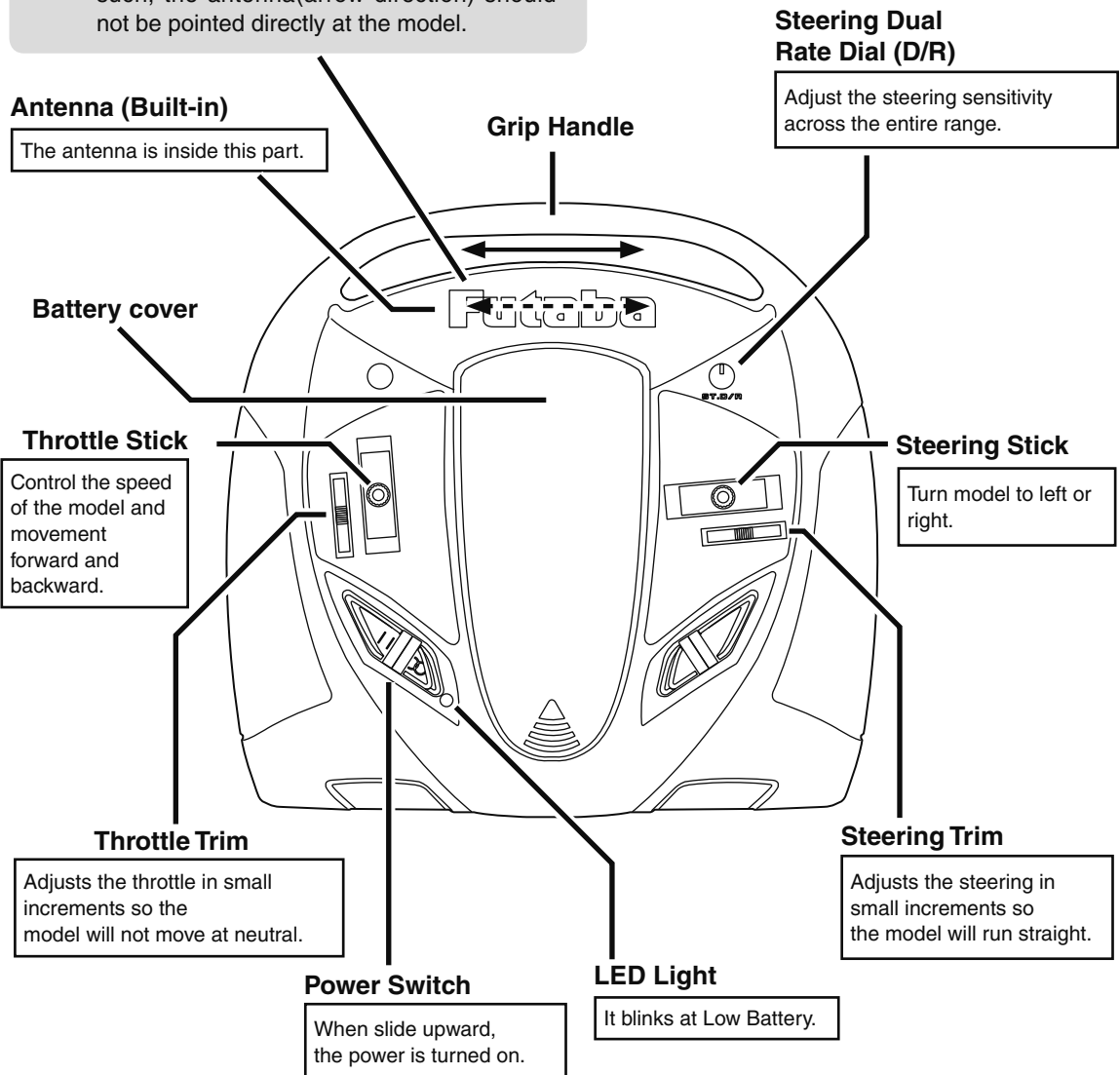

⚠ WARNING



Do not cover/hold the built-in antenna part of T2HR-2.4G transmitter by your hand during running.
Do not put any conductive plate/sticker on the antenna part.
Otherwise, the operating range may become shorter.

Remove the battery cover

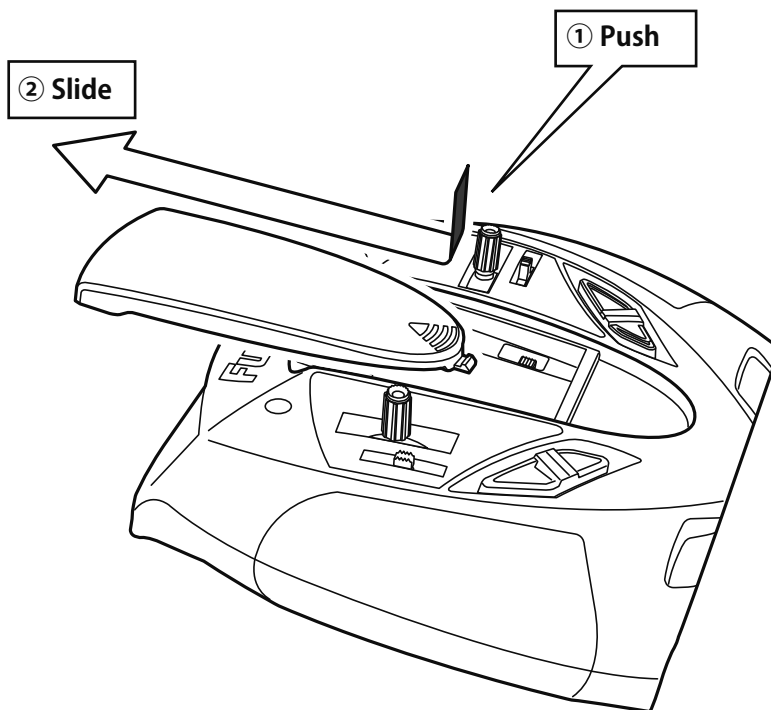

Caution : When remove battery cover

Hold the battery cover while removing it from the transmitter body so that it may not pop up.

Press the battery cover from the bottom side to top when it is removed.

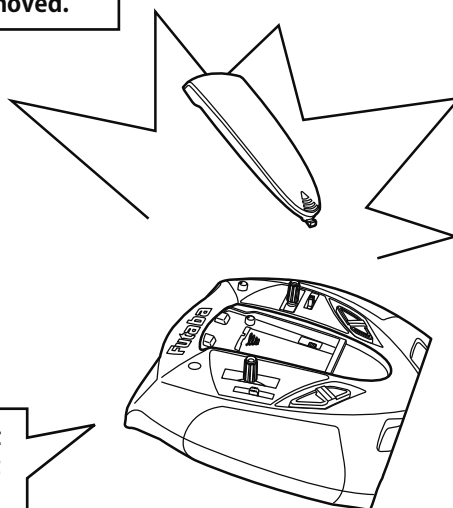
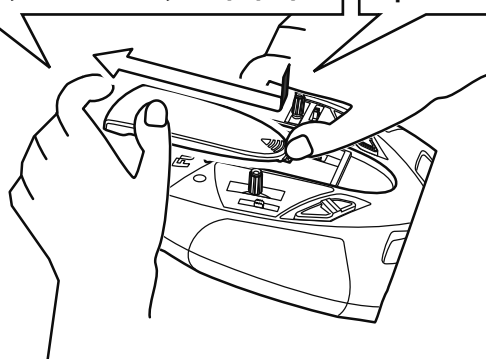

 The battery cover may pop up and get damage on your transmitter body without pressing it when it is removed.

Inside the battery cover

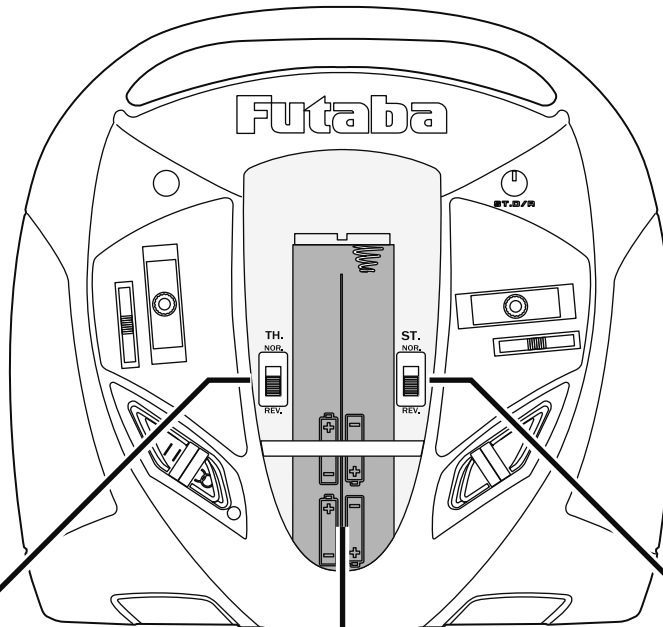
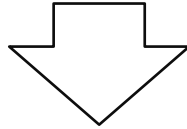
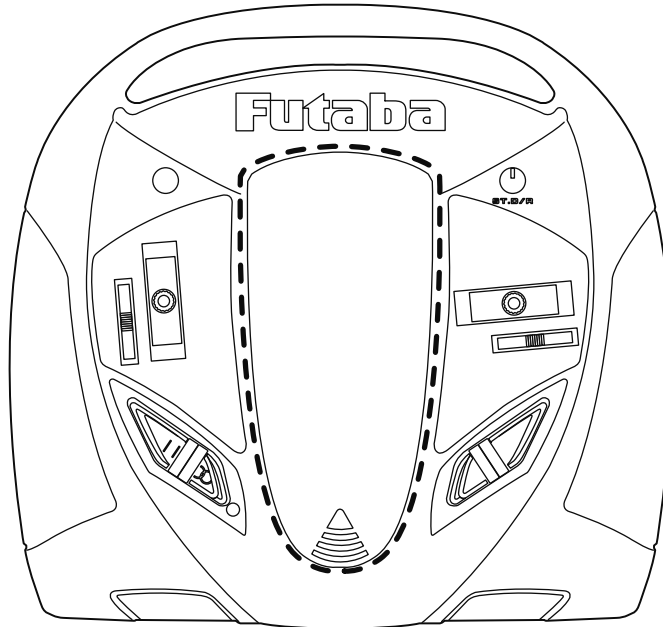

Throttle Servo Reversing Switch

Battery Box

4 AA size dry batteries

Steering Servo Reversing Switch

Battery Replacement Method

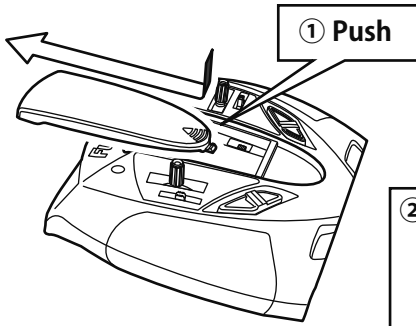

2 Remove the battery cover from the transmitter by sliding it to the direction of the arrow in the figure.

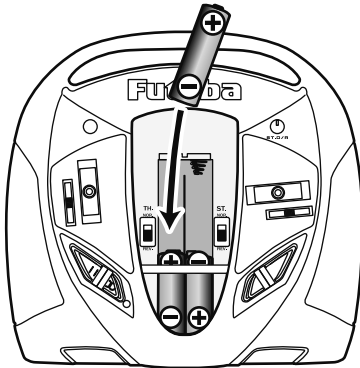

3 Prepare the new AA size batteries. Pay very close attention to the polarity markings and insert accordingly.

Attention ! + - Direction

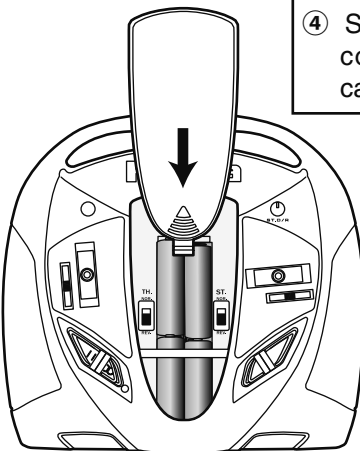
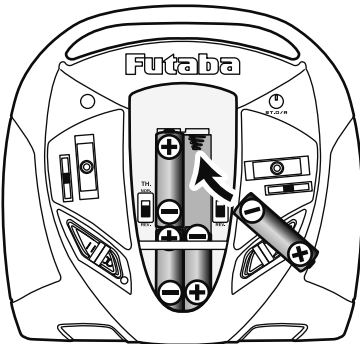

4 Slide the battery cover top onto the case.

Low Battery :

When the LED starts blinking, change the batteries immediately.

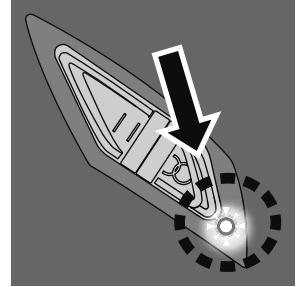

(If voltage is about **4.0v** or less, a **blink** indication of the **LED**.)

The low battery alarm is meant to be a safety feature only. Do NOT operate your radio below low battery. Always shut your radio off as soon as possible after the low battery warning loss of control.

CAUTION

Always be sure you reinsert the batteries in the correct polarity order. If the batteries are loaded incorrectly, the transmitter may be damaged.

When the transmitter will not be used for any short or long period of time, always remove the batteries. If the batteries do happen to leak, clean the battery case and contacts thoroughly. Make sure the contacts are free of corrosion.



⚠ CAUTION

- Do not charge a dry cell battery. Charging a dry cell battery will cause abnormal heating, etc. and is dangerous.

E.S.C. MC231CR / MC331CR

Applicable motors (Number of turns is criteria.)

- Use the MC231CR with a motor with 20T or more turns.
- Use the MC331CR with a motor with 13T or more turns.

*If a motor with a number of turns smaller than the above is used, the heat protector and overcurrent protection circuit may operate. The number of turns of the motor is only one criteria. Depending on the running conditions, the protection circuit may operate even if the condition above is satisfied.

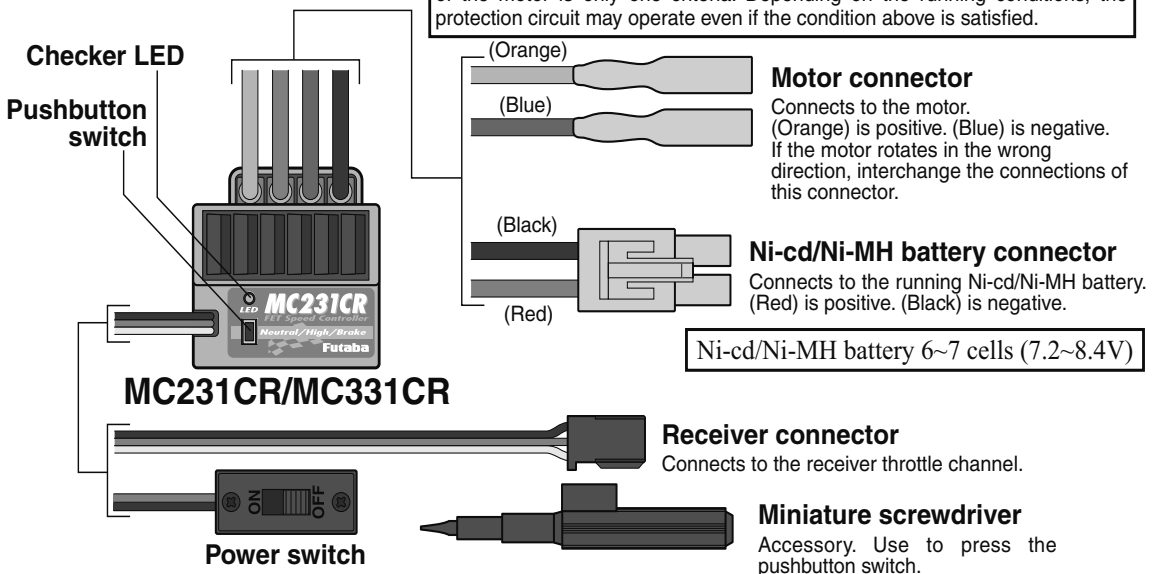

Power Switch

When slide upward,
the power is turned on.

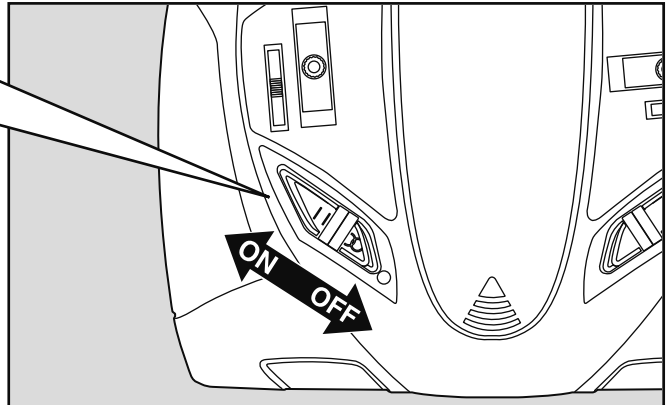

If the power switches are turned off in the opposite order the model may unexpectedly run out of control and cause a very dangerous situation.

Turning on the power switches

1. Turn on the transmitter power switch.
2. Turn on the receiver or speed control power switch.

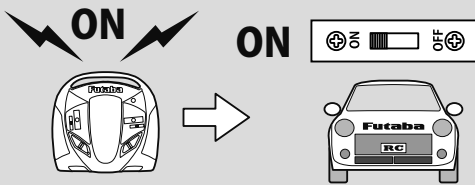

Turning off the power switches

Always be sure the motor is stopped.

1. Turn off the receiver or speed control power switch.
2. Then turn off the transmitter power switch.

-
-
-
-
-
-
-

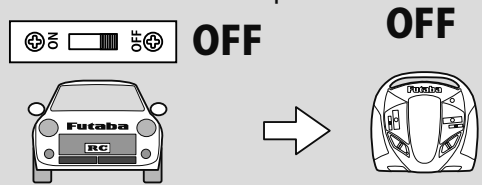

How to grasp of a transmitter

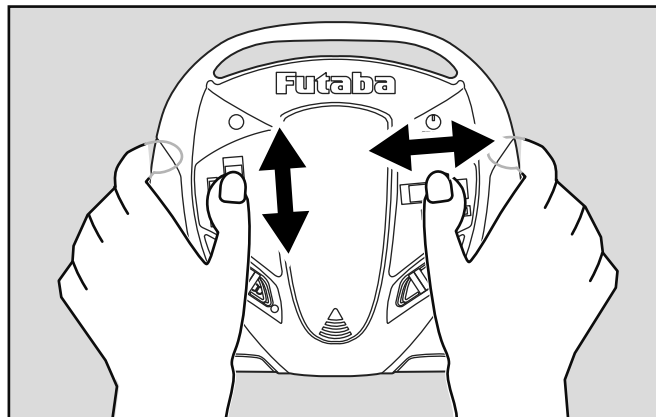

Linear Control

Stick control

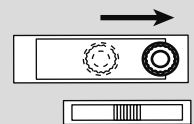
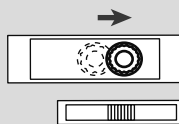
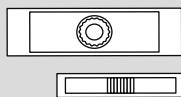

Servo movement

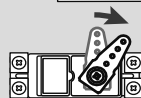
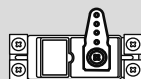

Steering Stick Control

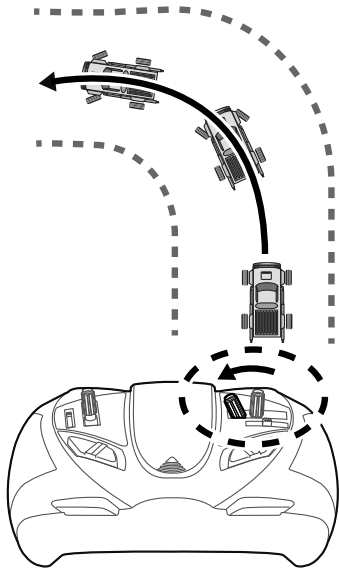

Turn model left

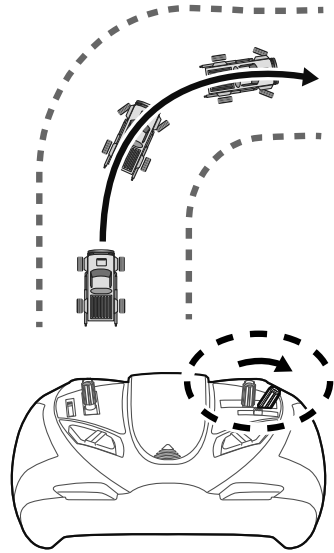

Turn model right

Throttle Stick Control

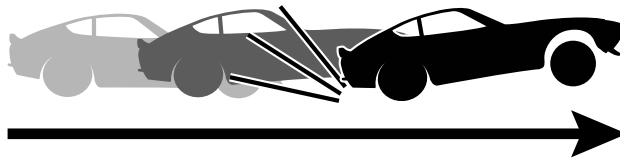
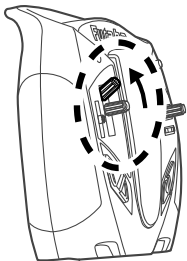

Forward

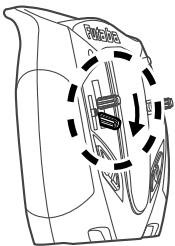

Stop

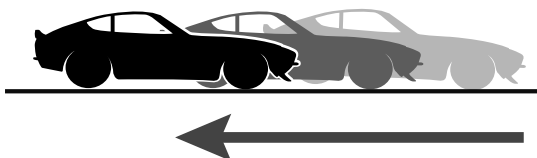

Backward

Receiver and Servo Connection

As you connect the receiver, servos and other components, do so in accordance with the "Assembly Precautions".

Connections when a E.S.C. MC231CR or MC331CR are used.

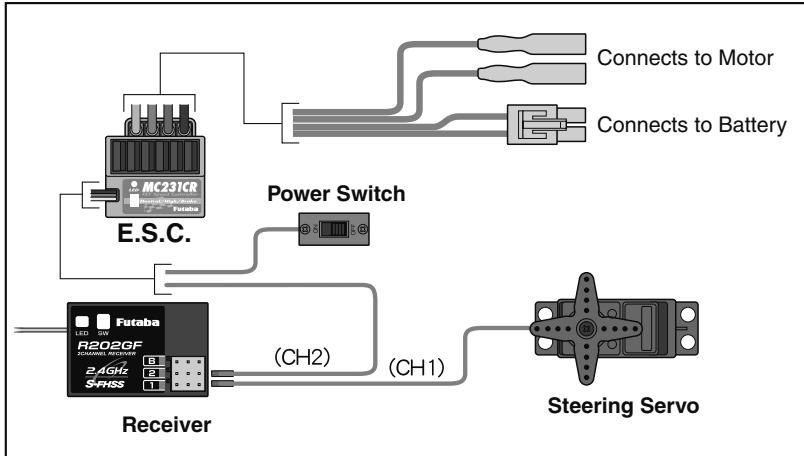

Gas Powered Model

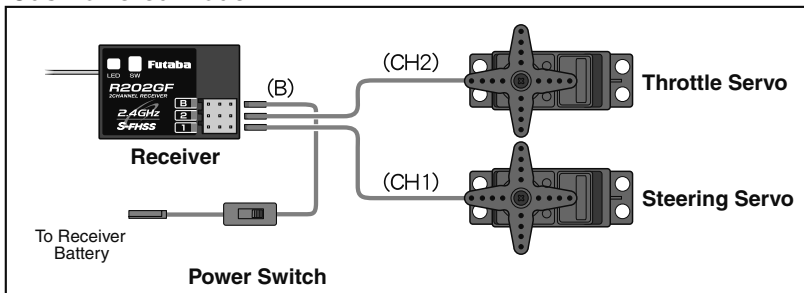

Receiver Antenna Installation

Install the R202GF receiver on the car as follows:

Note: The operating range may become shorter, depending on where the receiver and the antenna are mounted.

⚠ WARNING





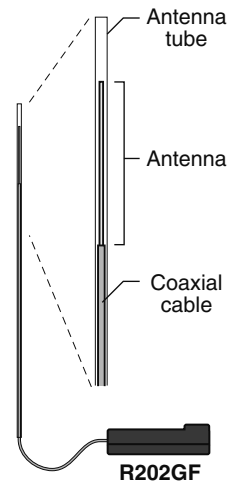



! Install the antenna in the higher place as shown in the figure. Keep the antenna as far away from the motor, ESC and other noise sources as possible. Put the antenna in the antenna tube to protect it.

⊘ Do not cut the antenna. Do not bend the coaxial cable. Doing so causes damage.



Assembly Precautions

WARNING

-
-  Check the receiver, servos, and battery connectors, to be sure they are firmly connected. If a connector is not fully inserted, vibration may cause the connector to work loose while the model is operating. This will result in loss of control.
-
-  Operate each servo horn over its full stroke and check to see that the linkage does not bind or is not too loose. Excessive force applied to the servo horn by binding or poor installation may lead to servo problems and result in loss of control.
-
-  **(Electric Cars and Boats)**
Isolate the receiver from vibration by attaching to the chassis or mounting plate with thick double sided tape.
 -  **(Gas Powered Cars and Boats)**
Isolate the receiver from vibration by wrapping it in foam rubber or similar type cushioning material. Protect the unit from water damage by placing it in a plastic bag or waterproof radio box. The receiver contains precision electronic parts. These parts are vulnerable to vibration and shock. Any contact with moisture (water or condensation) may cause receiver malfunction and loss of control.
-
-  Use the servo horn screw. When the servo horn comes off, it becomes loss of control.
-
-  Keep all devices that emit high frequency noise, such as motors, batteries, and wiring that handles heavy current loads, at least 1/2 inch away from the receiver and the receiver antenna. High frequency noise will cause a decrease in operating range and could cause loss of control.
-
-  Install electronic speed control heat sinks as well as other components that conduct electricity so they can not come in contact with aluminum, carbon fiber or other materials that conduct electricity. If, for example, the speed control came loose while the model was running and touched an aluminum chassis, a short circuit may occur that would cause irreparable damage to the system as well as loss of control.
-
-  Noise suppression capacitors should be installed on almost all motors. If the proper capacitors are not installed, high frequency noise will reduce range and cause loss of control along with various other problems.
-
-  Inspect all linkage installations and any point where metal could come in contact with other metal parts. Make sure these parts do not touch other metal parts under vibration. Should a linkage or other metal parts come in contact with other metal parts under vibration, the high frequency noise generated by this contact will cause interference and possible loss of control.

CAUTION

-
-  Do Not disassemble any part of this system that is not specified in the instruction manual. Futaba will not be responsible for any damage due to improper disassembly of any part of the radio control system.

How to link the transmitter and the receiver

Each transmitter has an individually assigned, unique ID code. In order to start operation, the receiver must be linked with the ID code of the transmitter with which it is being paired. Once the link is made, the ID code is stored in the receiver and no further linking is necessary unless the receiver needs to be used with an other transmitter. (For T/R set, the link is already done at factory.)

Link procedure

1 Bring the transmitter and the receiver close to each other, within 0.5 meter.

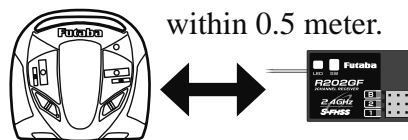

2 Turn on the transmitter and the receiver.

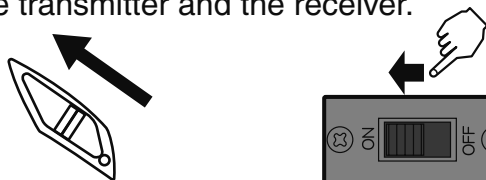

3 Push and hold the Link Switch of the receiver.

Push and hold the Link Switch

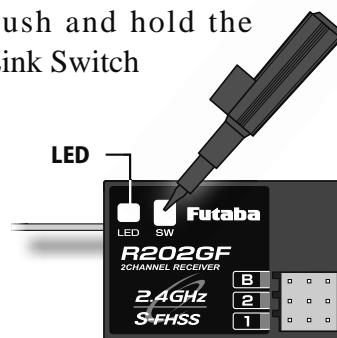

4 When the link is complete, the LED in the receiver changes to solid green.

*Please refer the table below for LED status vs receiver's condition.

LED status vs receiver's condition:

No signal reception	OFF
Receiving signals	On
Receiving signals, but ID is unmatched.	Blink
Receiving signals, when F/S is set.	It is turns on and a fast blink for the first one second.

⚠ WARNING

⚠ After the linking is done, please cycle receiver power and check that the receiver to be linked is really under the control of the transmitter.

⊘ Do not perform the linking procedure with motor's main wire connected as it may result in serious injury.

Fail Safe Function (F/S)

This function moves the throttle servo to a preset position when the receiver cannot receive the signal from the transmitter for some reason.

When the signal from the transmitter can be received again, this function automatically resets. The throttle position at the link operation is memorized.

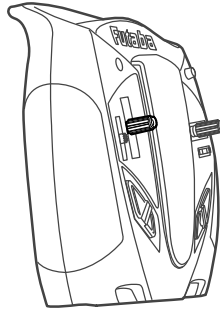

For an electric car (E.C.S use), link the transmitter and the receiver at neutral position.

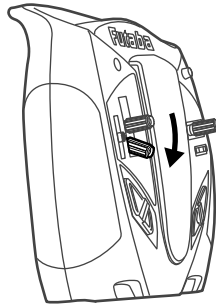

For the engine car, link the transmitter and the receiver at braking position.

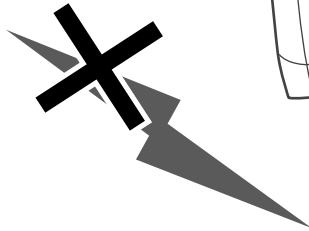

Transmitter Set-Up Procedures

*When making these settings adjustments, do so with the motor disconnected or the engine not running.

Servo Horn Installation Instructions

1 Connect the receiver, servos, and other components and then turn on the power switches to transmitter and receiver.

*Both servos will move to the neutral position.

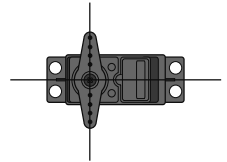

2 At this time install the servo horn in the manner described in the instruction manual provided with the model this system will be used in.

Reversing The Servo Operation Direction

Should the servo operate in the opposite direction required for your application, reverse the direction with the servo reversing.

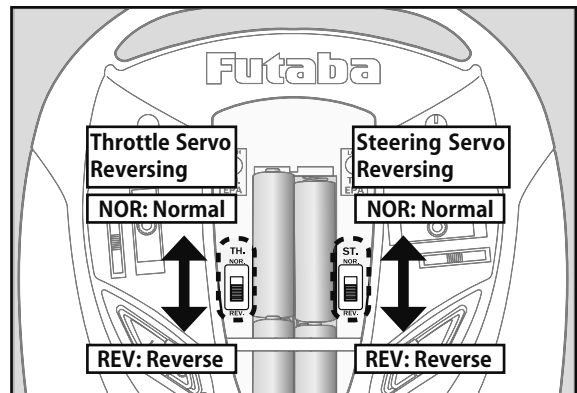

E.S.C. MC231CR / MC331CR

NEUTRAL, HIGH, AND BRAKE MAX POINT SETTINGS

Before setting each point, set the transmitter throttle channel trim to neutral.

1 Turn on the power in transmitter → amp order.

	Transmitter throttle operation	MC231CR (Pushbutton switch operation)	(Checker LED)
2 Neutral point setting	<p>•Neutral state</p>	<p>•Press the pushbutton switch. (0.5 secs or longer) (Confirmation beep sounds)</p>	<p>•Continuous single blink</p>
3 High point setting	<p>•Full high state</p>	<p>•Press the pushbutton switch. (Confirmation beep sounds)</p>	<p>•Continuous double blink</p>
4 Brake MAX point setting	<p>•Full brake state</p>	<p>•Press the pushbutton switch. (Confirmation beep sounds.)</p>	<p>•If the LED goes out, setting is complete.</p>

If the LED does not go off but blinks rapidly, setting was not performed normally. Repeat setting from "Neutral point setting".



* Since the data is read at the end of setting of all points, the points cannot be set independently.

* If the amp power was turned off during setting, the setting points cannot be memorized. (The previous settings are retained.)

* The confirmation beep sounds only when the motor was connected.

Steering Trim

Steering neutral adjustments can be made by moving the Steering trim knob to the left or right.

Racers Tip

When you install a servo, always check to be sure the servo is at its neutral position. Adjust the servo horn hole position and linkage so both are parallel. When a servo saver is used, place it as close to center position as possible. Be sure the steering trim on the transmitter is at the neutral position.

Trim Operation And Maximum Travel

Changing the trim can affect the overall settings. When adjustments are made with the trims, recheck your installation for maximum travel. (Steering D/R).

When Trim usage is extreme

If it takes most of your trim movement to get a servo to the neutral position, reposition the servo horn or servo saver on the servo and inspect your linkage installation.

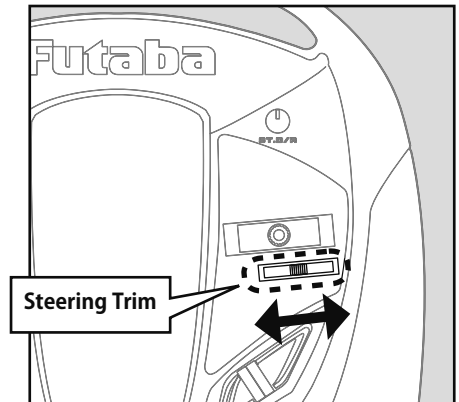

Direct Servo Saver Horn

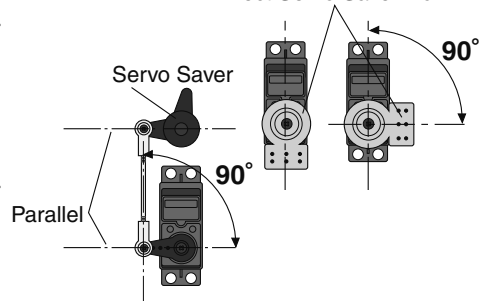

Throttle Trim

Throttle neutral adjustments can be made moving the throttle trim to the left or right.

Racers Tip

When using an electronic speed control, set the throttle trim to neutral and make adjustments to the speed control. On a gas powered model, set the trim to neutral and adjust the linkage to the point where the carburetor is fully closed in accordance with the engine instruction manual.

Trim Operation and Travel

Trim adjustments will affect the overall servo travel. Check the brake side (backward) movement when changes are made.

When trim movement is extreme

If you use most of the trim movement to get the servo to the neutral position, recenter the servo horn closer to the neutral position and inspect your throttle linkage.

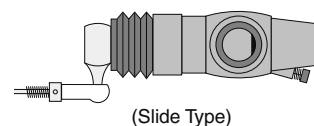
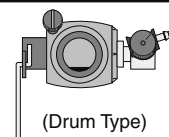
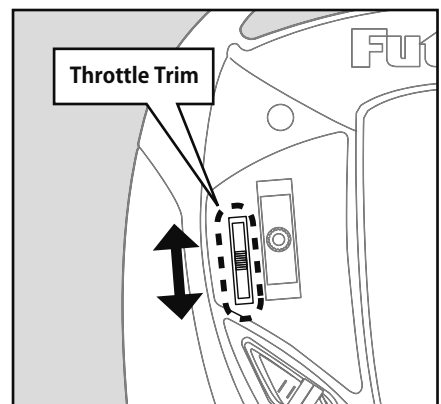

Steering Dual Rates

Use this function to adjust the steering travel of your model. If the model understeers (push) while cornering, add steering by turning C,W of the D/R button. When the model oversteers (loose), take away steering by turning C,C,W of the D/R button.

⚠ WARNING

⚠ Be sure that the steering linkage does not bind or come in contact with any suspension parts or arms. If unreasonable force is applied to the servo, the servo may be damaged and result in loss of control.

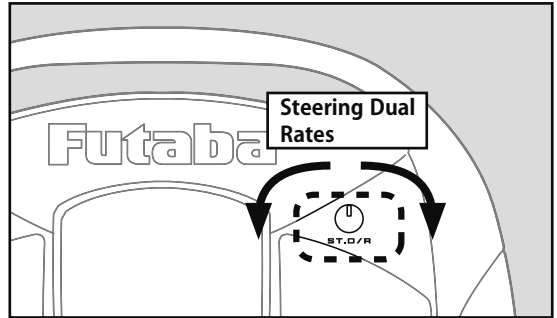

⚠ CAUTION

⚠ Adjust the Steering Trim after adjusting the Steering Dual Rate Dial.

Servo Reversing

This function reverses the rotation direction of the servo.

When the trim position deviates from the center, the deviation will be on the opposite side when the servo is reversed.

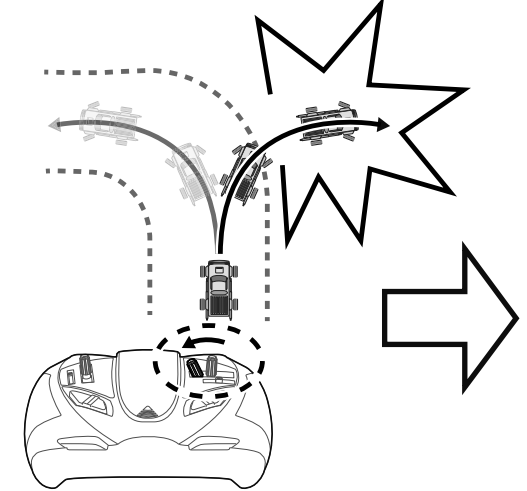
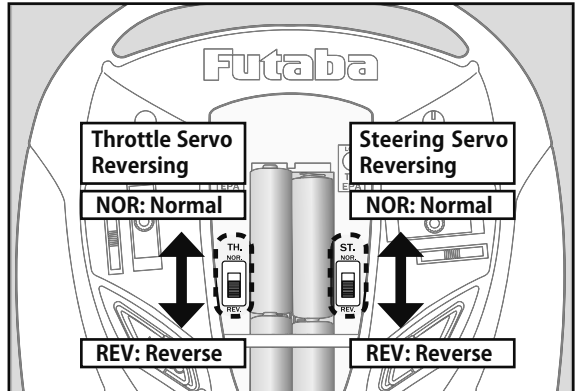
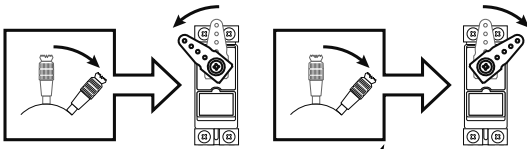

It operated a steering to the left, but a car turned right.

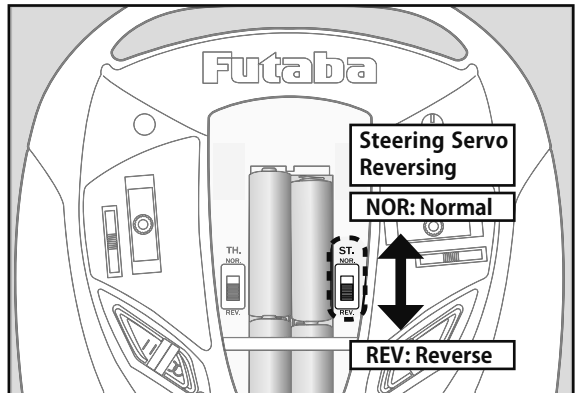

Change the direction of the steering reversing switch.

MC231CR/MC331CR Function

CANCELLING THE REVERSE FUNCTION

The amp reverse function can be cancelled by the following method so that the model can be used even in races that prohibit reverse running. (Brake operation only)

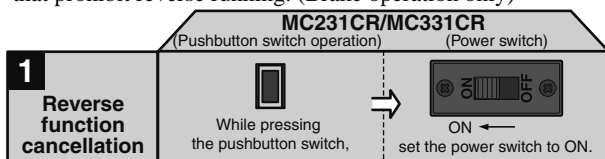

* When desired, you can enable the cancelled reverse function by repeating the operation shown at the left. (The reverse function is switched alternately.)

BRAKE/REVERSE OPERATING INSTRUCTIONS

Operation can be switched to reverse operation by returning the throttle stick from the brake position to the neutral position.





PROTECTION CIRCUIT OPERATION

The following protection circuits are built into the MC231CR. When a protection circuit operates, remove the cause before operating the model again.

Overcurrent protection	When an overcurrent flows due to an output short circuit, etc., the overcurrent protection circuit automatically limits the current to protect the FET. ⇒ Remove the cause of the short circuit, etc. before operating the model again.
Heat protector	When abnormal heating of the FET due to an overload, etc. is detected, the heat protector operates so that the speed is gradually reduced. ⇒ When the FET temperature drops, the heat protector automatically resets. However, remove the cause of the overheating before operating the model again.
Low voltage operation	When the NiCd/NiMH battery voltage drops, this function limits the motor output current and ensures steering operation. ⇒ After the speed drops, immediately recover the vehicle.

CHECKER LED DISPLAY

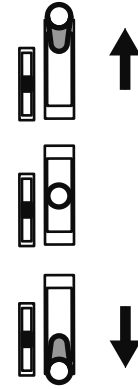
The amp operates linearly in proportion to the amount of forward, reverse, and brake operation. The amp operating state can be checked with the checker LED as shown below.

Operation	Checker LED display
Amp power ON	(Reverse operation set) Single blink (Single confirmation beep)  (Only brake operation set) Double blink (Two confirmation beeps) 
 <p>High point ↑ Forward</p> <p>Neutral point ○</p> <p>Reverse /brake ↓ Brake MAX point</p>	Off
	On *Becomes brighter nearer the high point.
	Off
	On *Becomes brighter nearer the brake MAX point.
(Amp power left on alarm) When the transmitter power was turned off first.	Blinks. (Confirmation beep also sounds.)  *Not used with PCM receivers. *When the transmitter is OFF, this function is not performed in environments such that the servo operates erroneously.

* Confirmation beep only sounds when the motor was connected.

MC231CR/MC331CR Operation

Forward :

Throttle stick is turned up, the speed increases.

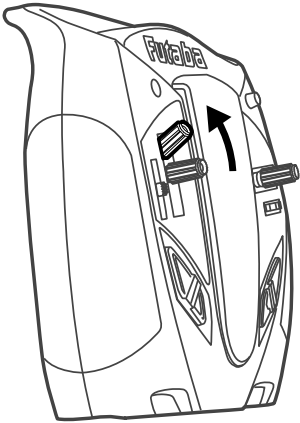

Brake :

Throttle stick is turned down, the brake works.

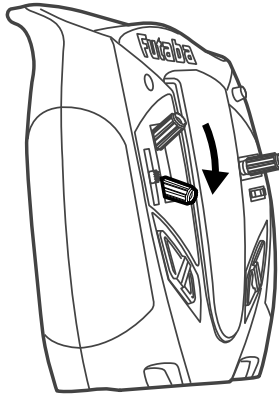

Reverse :

Operation can be switched to reverse operation by returning the throttle stick from the brake position to the neutral position. Then turn down the stick.

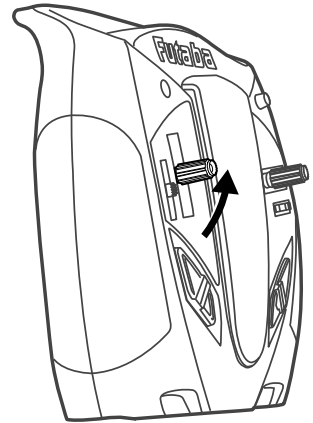

Stick is turned down from the neutral.

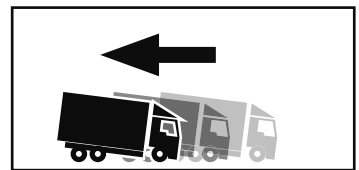
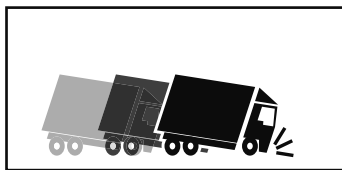
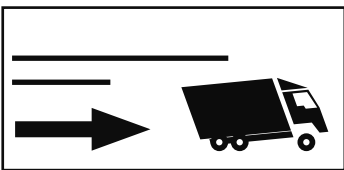
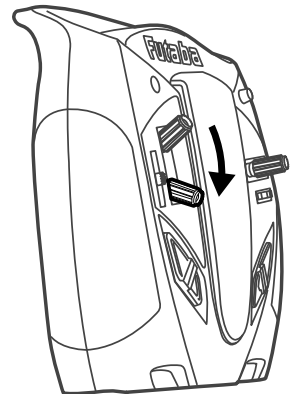

Changing the Neutral Position

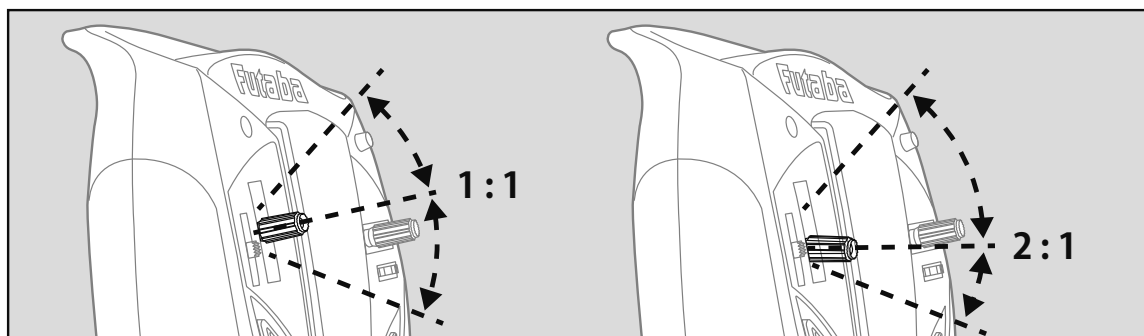

Change the neutral position only when large forward stroke of the throttle stick is need when using an FET E.S.C., etc.

(The neutral position is set to the center at the factory.)

*However, when returning from the 2:1 to the 1:1 position (neutral center), return the setting lever to the 1:1 side with the stick lever pushed to the HI side. Other-wise, the setting lever cannot move.

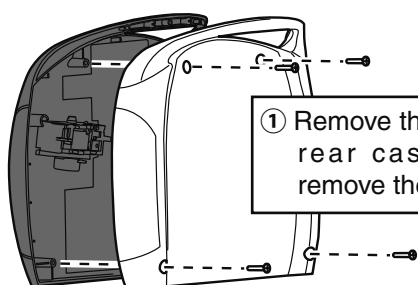

① Remove the four transmitter rear case screws and remove the front case.

② Move the setting lever at the throttle stick body to the outside.

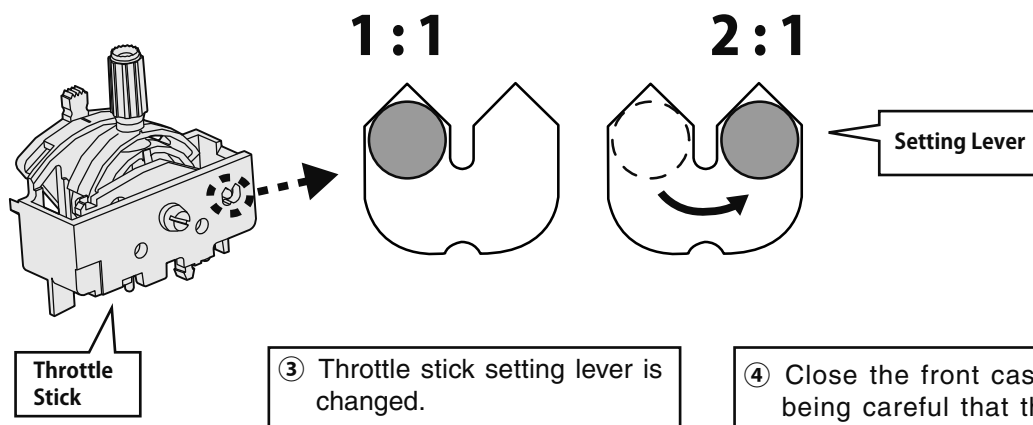

③ Throttle stick setting lever is changed.

④ Close the front case while being careful that the stick levers, trim levers, power switch, LEDs, and battery contacts do not get caught. And tighten the four screws.

Modifying the Throttle Stick to a Ratchet Type

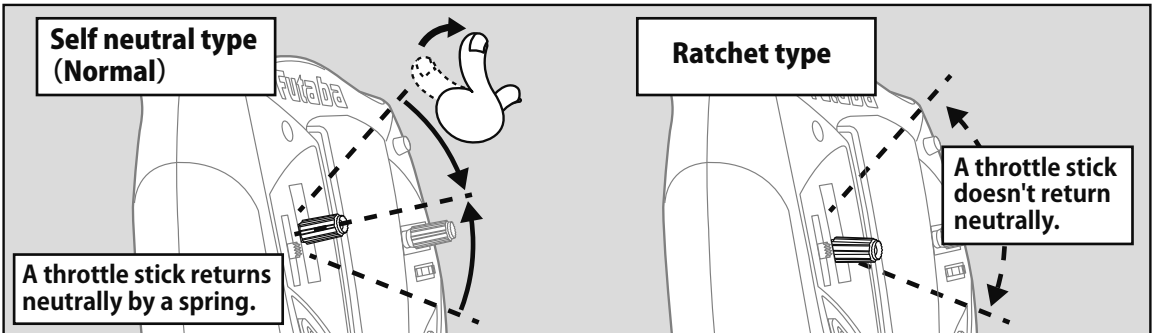

Open the transmitter front case and modify the stick section.

*The ratchet plate (sold separately) is necessary for this modification.

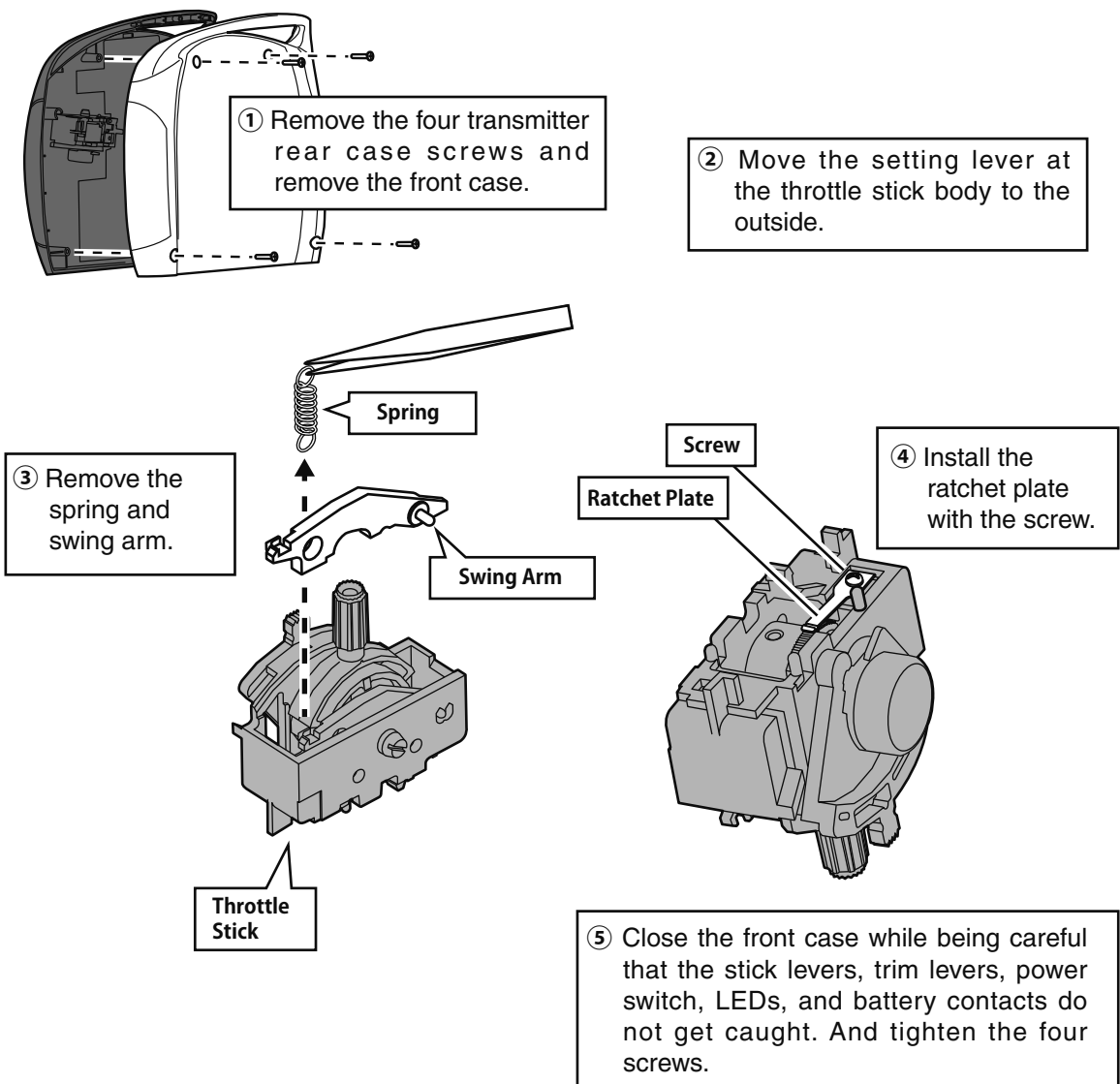

Ratings

Communication method:

One-way operation system

Maximum operating range:

200m (Optimum condition)

For safety:

F/S (Throttle), ID (About 4 billion ways of pair identifications)

Transmitter T2HR

(FHSS system, Stick type, 2 channels)

Transmitting frequency:

2.4GHz band

Power requirement:

(Dry cell battery) Penlight x 4(6V)

Current drain:

100mA

Transmission antenna:

1/2λ di-pole (Built-in)

Receiver R202GF:

(FHSS/S-FHSS system, 2 channels)

Power requirement:

4.8V ~ 7.4V Rechargeable battery

Size:

23x35x9mm (excluding a projection part)

Weight:

6g

Servo S3003

(Standard servo)

Power requirement:

6V (common with receiver)

Current drain:

8mA (at 6V / Idle)

Output torque:

4.1kg-cm (57in.-oz.) at 6V

Operating speed:

0.19sec/60 degree at 6V

Size:

40.4x19.8x36mm (1.59x0.78x1.42in.)

Weight:

37.2g (1.31oz.)

E.S.C. MC231CR / MC331CR

(Electronic speed control)

Operating system:

Forward, reverse, and brake operations are all linear.

Power requirement:

Ni-Cd/Ni-MH battery 6-7 cells (7.2 to 8.4V)

PWM frequency:

1.5kHz (fixed)

Setting:

One-touch input by pushbutton switch. Set data is saved to built-in EEPROM.

Current capacity (FET rating):

Forward=90A/200A, reverse=45A/100A

Size:

27.1x33.3x12.8mm (1.07x1.31x0.50in.)
(excluding protruding parts)

Silicon cord gauge size:

AWG16/AWG14 equivalent

Weight:

44/45g (1.55/1.59oz.)
(including connectors and switches)

BEC voltage:

6.0V

NOTE: Futaba FHSS system, T2HR transmitter and R202GF receiver, does not work with current Futaba FASST/FASSTest/T-FHSS system. Please use T2HR and R202GF in pairs. Futaba FASST/FASSTest/T-FHSS system and FHSS system are not compatible each other.

Troubleshooting

If your system fails to operate or you experience a short range problem or erratic control, check the table below for possible causes. If after you have followed the suggestions listed the problem is not corrected, return the system to our service department for inspection and repair.

(Item Check)

Transmitter

Battery

- Dead battery → Change the batteries.
- Batteries inserted incorrectly. → Reload the batteries in accordance with the polarity markings
- Faulty contact → Check to see if the contacts are bent and not making good contact
- Dirty contacts → Clean the contacts and check for corrosion.

Receiver

Battery

- Dead battery → Replace or recharge
- Wrong polarity → Check connections

Antenna

- Near other wiring → Move away from wiring
- Was antenna cut → Request repair
- Is the antenna installed correctly → Refer to the receiver installation.

Monitor LED

- Check the LED of the receiver.
- Refer to the "How to link the transmitter and the receiver".

Connector connections

- Wiring incorrect → Insert all connectors firmly
- Loose connections → Push the connector in firmly

Linkage

- Binding or loose → Adjust the linkage in model
- Is movement stiff → Adjust linkage in model

Motor (Electric powered)

- Noise problems → Install capacitors on motor

Error Displays

Low Battery

When the LED starts blinking, replace the batteries immediately.

LED light:

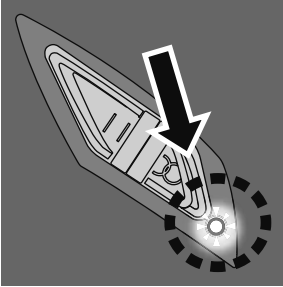

⚠ WARNING



When a low battery alarm is generated, cease operation immediately and retrieve the model. If the battery goes dead while in operation, you will lose control.

When requesting repair

Before requesting repair, read this instruction again and recheck your system. Should the problems continue, request as follows.

(Information needed for repair)

Describe the problem in as much detail as possible and send the letter along with the system in question.

- Symptom (Including the conditions and when the problem occurred)
- R/C System (Send transmitter, receiver and servos)
- Model (Type of model, brand name and model number or kit name)
- Detailed packing list (Make a list of all items sent in for repair)
- Your name, address and telephone number.

(Warranty)

Read the Warranty card.

- When requesting warranty service, send the card or some type of dated proof of purchase.

Hobby Services (U.S. only)

Futaba Service Center

3002 N Apollo Drive Suite 1, Champaign, IL 61822 U.S.A.

TEL (217)398-8970 or E-mail: support@hobbico.com (Support)

TEL (217)398-0007 or E-mail: futabaservice@hobbico.com (Service)

FUTABA CORPORATION Phone: +81 475 32 6982, Facsimile: +81 475 32 6983
1080 Yabutsuka, Chosei-mura, Chosei-gun, Chiba-ken, 299-4395, Japan

©FUTABA CORPORATION 2015, 6 (1)